

KENWOOD

KAC-PS400M

MONO POWER AMPLIFIER ▶ Page 2-14

INSTRUCTION MANUAL

AMPLIFICATEUR DE PUISSANCE MONAURAL ▶ Page 16-28

MODE D'EMPLOI

AMPLIFICADOR DE POTENCIA MONOFONICO ▶ Page 30-42

MANUAL DE INSTRUCCIONES

KENWOOD CORPORATION

Take the time to read through this instruction manual. Familiarity with installation and operation procedures will help you obtain the best performance from your new power amplifier.

For your records

Record the serial number, found on the back of the unit, in the spaces designated on the warranty card, and in the space provided below.

Refer to the model and serial numbers whenever you call upon your KENWOOD dealer for information or service on the product.

Model KAC-PS400M Serial number _____

Safety precautions

▲WARNING

Take the following precautions to prevent fire and avoid personal injury :

- When extending the battery cable, or ground cable, use 5mm² (AVG10) or larger automotive grade cable to avoid cable deterioration or damage to the covering.
- Check that no metal objects (coins, tools, etc.) are left inside the unit to avoid short circuits.
- If you smell or see smoke, turn the power off immediately and consult your Kenwood dealer.
- Do not touch the unit during use because the surface of the unit becomes hot and may cause burns if touched.

▲CAUTION

Take the following precautions to keep the unit in proper working order.

- Be sure the unit is connected to a 12V DC power supply with a negative ground connection.
- Do not open the top or bottom cover.

- Do not install the unit in places it is exposed to direct sunlight, high heat or humidity, water may splash over it, or dust exists.

NOTE

If you have difficulty in installing this unit in your vehicle, contact your Kenwood dealer.

Cleaning the unit

If the surface is dirty, wipe it clean with a silicon cloth or soft dry cloth with the power off.



▲CAUTION

Do not use hard cloths or paint thinner, alcohol, or other volatile solvents. These may damage external surfaces or remove indicator characters.

FCC WARNING

This equipment may generate or use radio frequency energy. Changes or modifications to this equipment may cause harmful interference unless the modifications are expressly approved in the instruction manual. The user could lose the authority to operate this equipment if an unauthorized change or modification is made.

Accessories

Part name	External View	Number of Items
Self-tapping screws ($\varnothing 5 \times 18\text{mm}$)		4
Terminal cover (Power terminal)		1

Installation

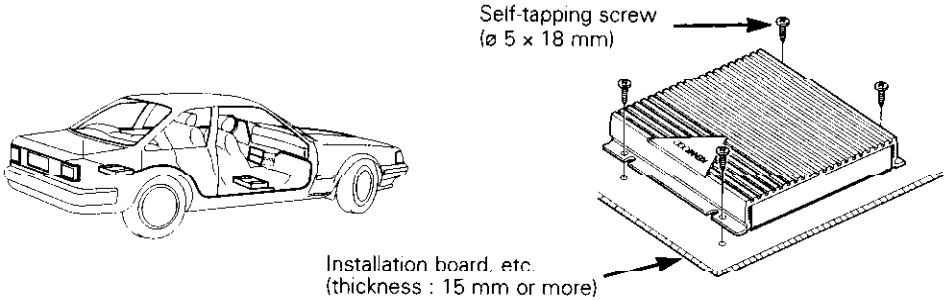

Since the power amplifier has no parts which require operation, it can be installed at a position away from the driver's seat without any hindrances.

As generally accepted positions for its installation, places such as inside the trunk, etc. can be considered.

CAUTION

- Do not install the unit under the carpet. Otherwise heat build-up occurs and the unit may be damaged.
- Install this unit in a location which allows heat to easily dissipate.
Once installed, do not place any object on top of the unit.
- This unit has cooling fans to decrease the internal temperature. Be careful not to block the cooling fan openings when installing the unit. Blocking these openings will inhibit the cooling of the internal temperature and result in malfunction.
- After installing the unit, check to make sure that electrical equipment such as the brake lamps, turn signal lamps and windshield wipers operate normally.
- Install the unit securely in a location that does not interfere with driving.

Controls

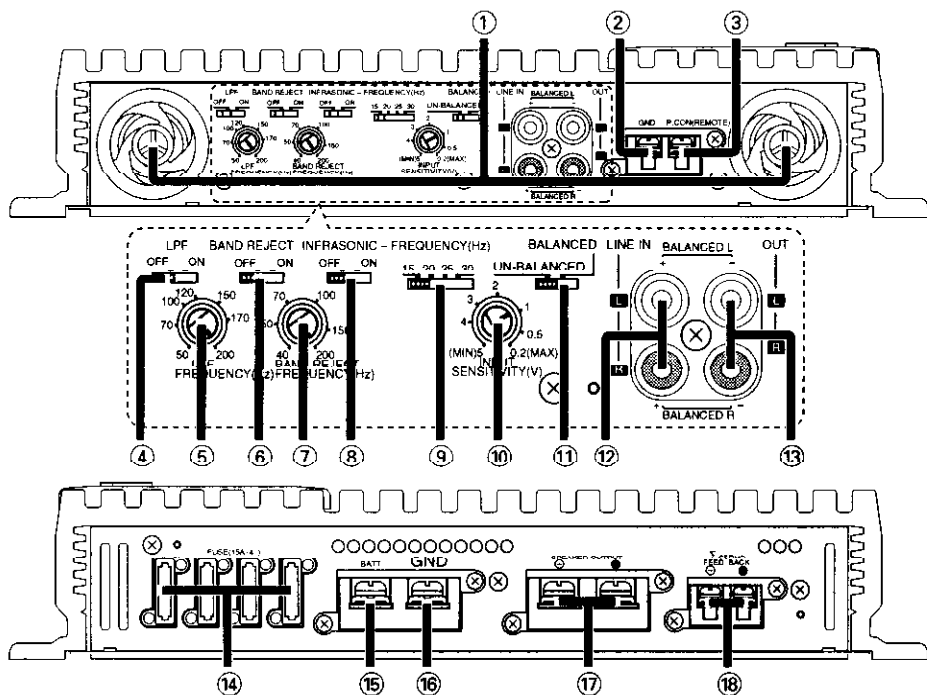

① **Cooling fans**

When the internal temperature of the amplifier rises, the cooling fans are activated automatically to drop the temperature. In certain situations, the cooling fans may be operating from the beginning of the amplifier operation.

② **RCA cable ground lead terminal**

③ **Power control (REMOTE) lead terminal**

④ **Low Pass Filter switch**

When this switch is set to ON, the bass is boosted because the frequencies of the lower frequency band than the cutoff frequency set with the LPF FREQUENCY control are output.

⑤ **LPF FREQUENCY control**

Sets the cutoff frequency when the FILTER switch is set to LPF.

⑥ **BAND REJECT filter switch**

When this switch is set to ON, frequencies in the band set with the BAND REJECT FREQUENCY control are rejected and eliminated. The band rejection allows to reduce resonance inside the vehicle

compartment and standing waves. (See P.7)

⑦ **BAND REJECT FREQUENCY control**

Sets the rejection frequency when the BAND REJECT switch is set to ON. (See P.7)

⑧ **INFRASONIC FILTER switch**

When this switch is set to ON, the inaudible, ultralow frequencies below the frequency set with the INFRASONIC FILTER FREQUENCY switch are cut off. This improves the reproduction performance of the speakers by eliminating unnecessary oscillations which will not become sound.

⑨ **INFRASONIC FILTER FREQUENCY switch**

Switches the cutoff frequency when the INFRASONIC FILTER switch is set to ON.

⑩ **INPUT SENSITIVITY control**

Adjust this control according to the pro out level of the center unit connected to this amp.

NOTE

- Refer to "Specifications" on the center unit's instruction manual about the pre-out

level.

- The input level of signals sent through balanced transmission is twice that of signals sent through unbalanced transmission. Therefore, be sure to decrease the input sensitivity (toward MIN.).

⑪ **BALANCED INPUT CHANGEOVER switch**

Switches the line input and output terminal connections.

- **UNBALANCED position:**
Set to this position when you want to output signal from the OUT sockets or use an ordinary connection (unbalanced transmission)
- **BALANCED position:**
Set to this position when using the balanced transmission which is less susceptible to noise.

⑫ **LINE IN terminal**

RCA input terminal. It can be used by setting the BALANCED INPUT CHANGEOVER switch as follows:

- When the switch is set to UN-BALANCED position:
These sockets are L and R LINE IN
- When the switch is set to BALANCED position:
These sockets are L+ and R+ LINE IN

⑬ **OUT terminal**

RCA input/output terminal. It can be used by setting the BALANCED INPUT CHANGEOVER switch as follows:

- When the switch is set to UN-BALANCED position:
These sockets are L and R LINE OUT
- When the switch is set to BALANCED position:
These sockets are L- and R- LINE IN

⑭ **FUSE (15 A × 4)**

⑮ **BATTERY terminal**

⑯ **Ground terminal**

⑰ **SPEAKER OUTPUT terminals**

As this unit accepts speakers with a minimum impedance of 2 ohms, connect speakers with 2-ohm or higher impedance to these terminals.

CAUTION

The rated input of the speakers should be no less than the maximum output of the amplifier. Otherwise malfunction may result

⑱ **SIGMA SERVO FEED BACK terminals (See p. 10)**

CAUTION

Be sure to make proper connections to the SIGMA SERVO FEED BACK terminals. Incorrect connection may result in lack of sound output or other malfunctions.

Balanced transmission

This makes the audio signal transmission less affected by noise by transmitting each signal by separating into the Hot (+) and Cold (-; symmetrical signal to Hot) to offset noise which may occur.

Infrasonic filter:

Ultralow frequencies that cannot be reproduced even by a subwoofer speaker do not become sound but become unnecessary oscillations, which affect the sound by causing distortion, etc. The infrasonic filter prevents this and improves the reproduction of the speakers by cutting ultralow frequencies below the audible band.

Power indicator

■Power indicator:

This lamp indicates the status of the unit, including the power supply and protection function, by lighting in red, amber or green or turning off.

When power is turned ON, it lights in green for a few seconds, then turns red when normal operation starts.

Power indicator

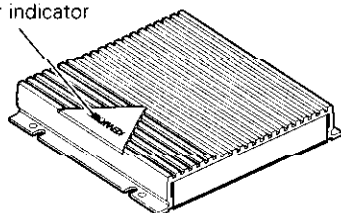

■The protection function is activated in the following situations:

This unit incorporates a protection function which protects the main unit and speakers from troubles. The unit stops to function when the protection function is activated.

•If the POWER INDICATOR lights in green:

- A speaker cable may be short-circuited.
- A speaker output may be in contact with the ground.
- The temperature of the internal parts may be higher than 120°C (248°F)
- The sigma servo connection may be erroneous.
- The fuse of this unit may be blown.
- The unit may be malfunctioning and sending DC signal to the speaker output.

•If the POWER INDICATOR does not light up:

- The grounding cable of this unit may not be connected with a metallic part which is electrically connected with the negative terminal of the battery.
- The power control cable may not be connected to this unit.
- The grounding cable of the center unit (cassette receiver, CD receiver, etc.) may not be connected with a metallic part which is electrically connected with the negative terminal of the battery.
- The fuse of this unit may be blown.

■Drop in supply voltage (If the POWER INDICATOR lights or blinks in amber):

As drop in the supply voltage decrease the power (output), the POWER INDICATOR lights in amber when the supply voltage drops below 11.5 V.

If the POWER INDICATOR blinks or lights in amber, check the following items and make sure to supply enough power to this unit.

- Is the battery cable too thin to supply enough power?
- Is the battery cable deteriorated?
- Is the battery exhausted?

▲CAUTION

Do not use thin or deteriorated cables for this may cause heat generation or burn. The cable used should be thick enough (5 mm² or more) to supply power.

BAND REJECT Filter

The acoustic properties of vehicle compartment tend to cause oscillation due to resonance or unclearness of sound due to standing waves at certain frequencies.

The band reject filter can solve the problems of resonance or unclear sound with minimum influence on the sound quality because it eliminates only the frequencies causing resonance or standing waves.

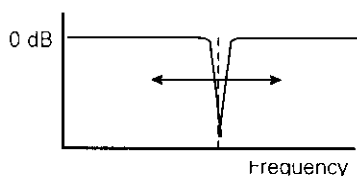

■ Adjustment method:

The band reject filter cuts only the limited frequencies to minimize influence on the sound quality. Therefore, its effect cannot be obtained unless the cutoff frequencies are set accurately to the frequencies causing resonance and standing waves. The band reject filter can be adjusted according to what you feel through your ears, but we recommend the use of a signal generator or a spectrum analyzer with a fine frequency measurement capability for the adjustment.

• Adjustment using a signal generator:

Output a sine wave, vary its frequency to find the frequencies at which the vehicle compartment resonates or volume increases (standing waves occur), and set the BAND REJECT FREQUENCY control to the position with which the resonance and standing waves disappear.

• Adjustment using a spectrum analyzer:

Output white noise (sound in which all frequencies are at a certain level), find the peak frequency observed on the spectrum analyzer, and set the BAND REJECT FREQUENCY control to the position with which the peak observed on the spectrum analyzer disappears.

Connection

Power and Speakers cable connection

Power terminal

Pass battery and ground cables through supplied terminal cover and connect to respective terminals. After completing connections, fasten terminal cover over terminal bracket.

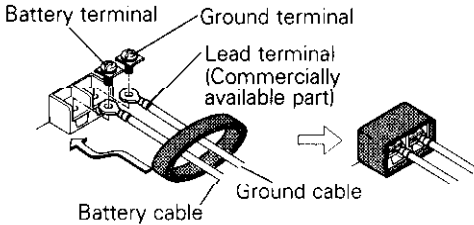

Speaker output cable terminal

Connect the speaker output cables to these terminals.

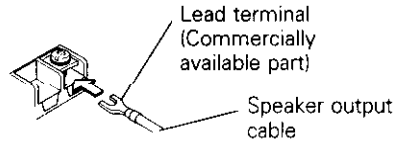

WARNING

To prevent fire caused by a short in the wiring, connect a fusible link or breaker nearby the battery's positive terminal.

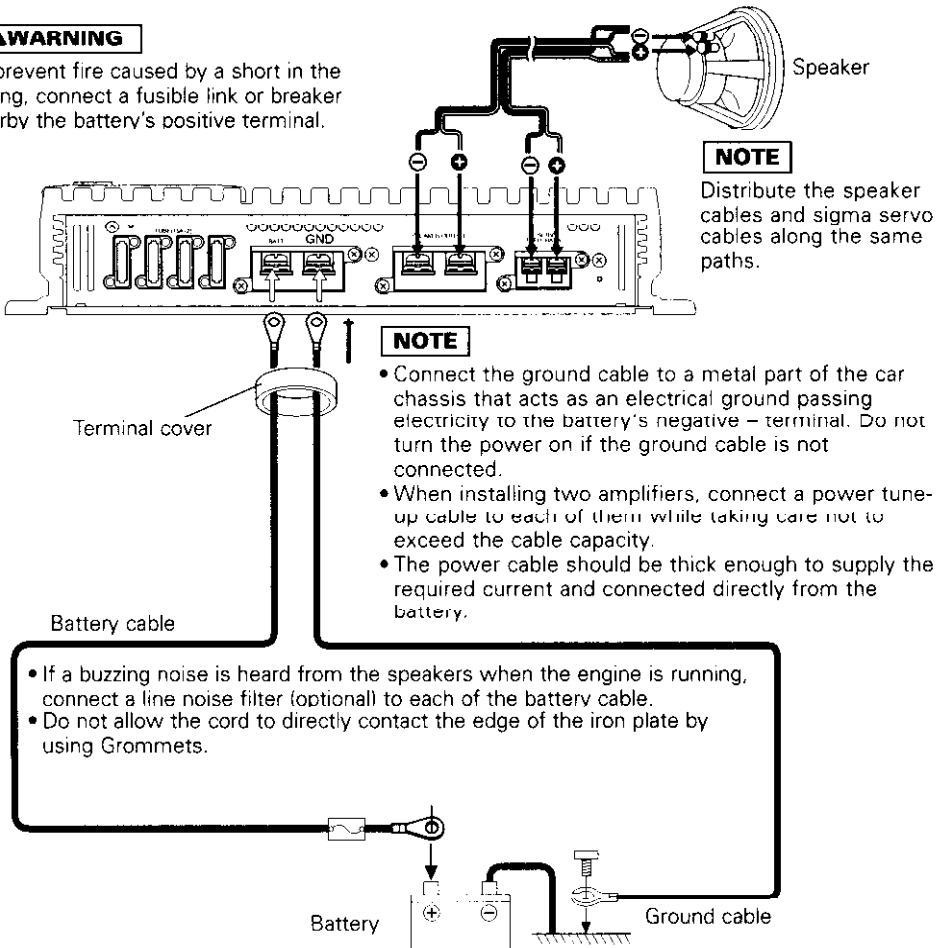

- If a buzzing noise is heard from the speakers when the engine is running, connect a line noise filter (optional) to each of the battery cable.
- Do not allow the cord to directly contact the edge of the iron plate by using Grommets.

■ RCA cable connection

Power control lead terminal

Connect the Center units's power control lead from the center unit.

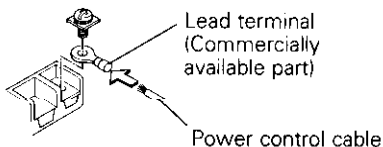

RCA cable ground lead terminal

When using an RCA cable with a ground lead attached, connect the ground lead to this terminal.

▲CAUTION

Do not use this terminal for power source grounding. This unit will be damaged if the power source grounding wire is connected to this terminal.

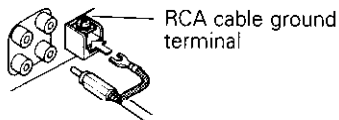

■ Stereo connection (Unbalanced)

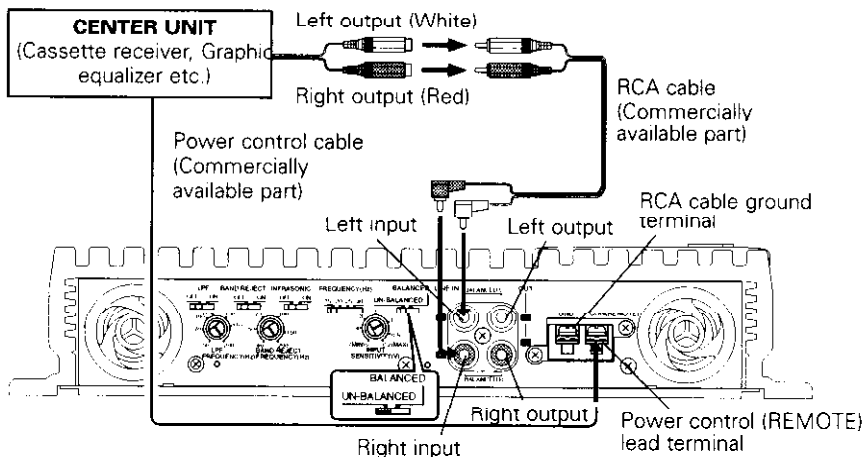

■ Stereo connection (Balanced)

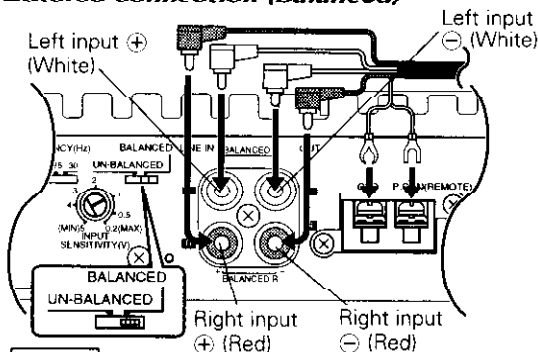

NOTE

Use the optional balanced transmission cable (KBC-600) when balanced signal connection is required.

■ Monaural connection

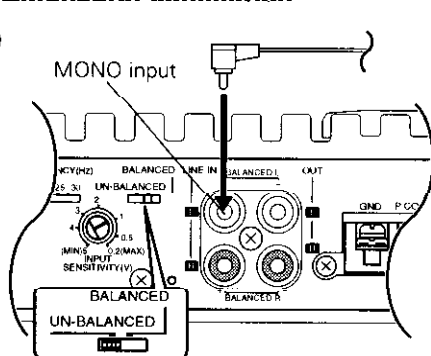

Sigma servo feed back

The sound reproduced through conventional amplifiers is distorted due to the counterelectromotive force produced in the oscillating system of the speaker. The counterelectromotive force is particularly high with the woofer which requires a large drive mass. The sigma servo connection reduces distortion caused by the counterelectromotive force by including the circuit up to the speaker terminals in the negative feedback loop. This makes it possible to drive speakers with more fidelity to the input signals and create a sharp bass sound image with few feeling of noise interference.

NOTE

The speaker cables and sigma servo cables should be distributed along the same paths.

CAUTION

- The extension of the negative feedback loop to include the speaker terminals makes it necessary to connect the sigma servo terminals correctly. Incorrect connection may result in sound degradation or other malfunction. If sound is not reproduced normally, check the connection of the sigma servo terminals, etc.
- If the Sigma servo terminals are not connected, the sound may fluctuate or noise may occur. Be sure to connect the Sigma servo terminals correctly.
- When connecting speakers in a parallel configuration, use speakers with an impedance of 4 ohms or more. Connecting speakers with smaller impedance than 4 ohms will cause malfunction.
- The rated input of the speakers connected to this unit should be no less than the maximum output of the amplifier. Otherwise malfunction may result. Be specially careful in this when connecting speakers in a parallel configuration.

Basic sigma servo connection

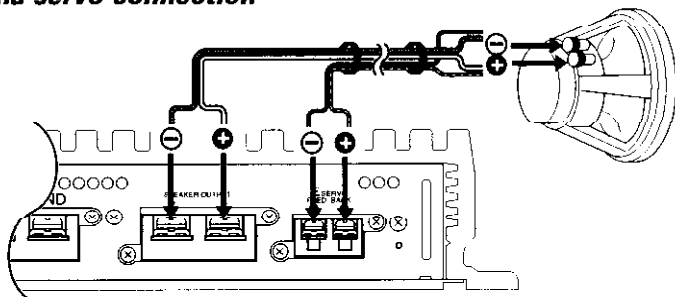

Series connection

CAUTION

Make this cable as short as possible.

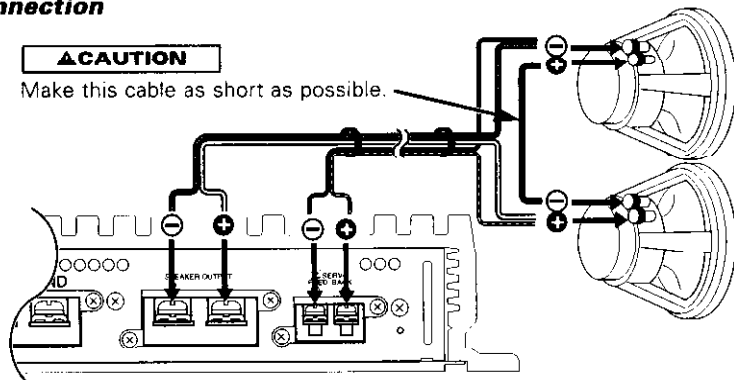

■ Parallel connection (1)

▲CAUTION

The speaker cables connected to this unit should be thick enough to supply the current capacity of two speakers.

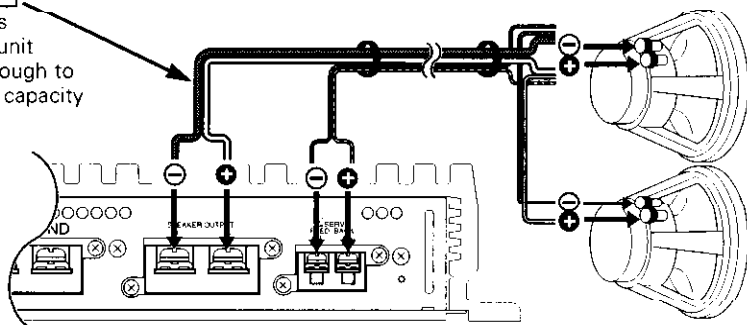

■ Parallel connection (2)

▲CAUTION

This connection is possible only when the speakers are identical and the speaker cables are also of the same type and length.

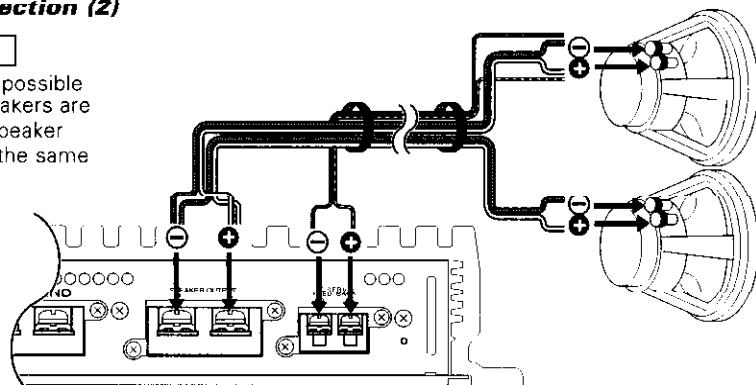

■ Simplified sigma servo connection (for Display purpose)

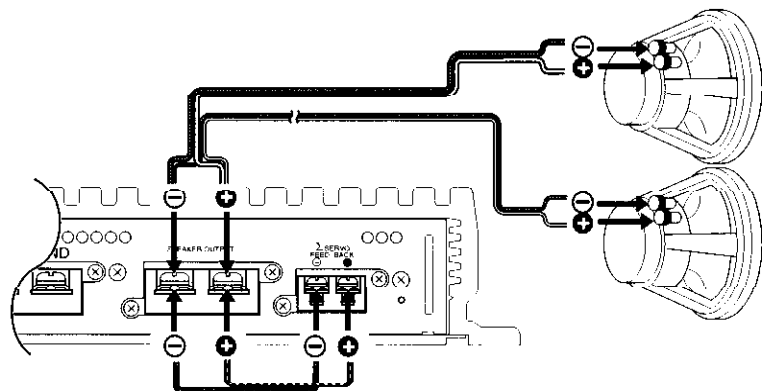

Installation procedure

Since there are large variety of settings and connections possible according to applications, read the instruction manual well to select the proper setting and connection. Improper setting and/or connection may result in sound degradation, noise generation or even total lack of sound.

1. Remove the ignition key and disconnect the negative - terminal of the battery to prevent short circuits.
2. Set the unit according to the intended usage.
3. Connect the input and output cables of the units.
4. Connect the center unit and this unit according to the required application.
5. Connect the speaker cables and sigma servo feed back cables.
6. Connect the power cable, power control cable and grounding cable following this order.
7. Install the unit in the car.
8. Connect the negative ⊖ terminal of the battery.
9. Turn power ON and ensure that sound is output normally.

▲CAUTION

If sound is not output normally, immediately turn power off and check connections. Be sure to perform the sigma servo connection correctly.

▲CAUTION

- Be sure to make correct connections of the sigma servo terminals.
- Be sure to turn the power off before changing the setting of any switch.
- If the fuse blows, check cables for shorts, then replace the fuse with one of the same rating.
- Check that no unconnected cables or connectors are touching the car body. Do not remove caps from unconnected cables or connectors to prevent short circuits.
- Connect the speaker cables to appropriate speaker connectors separately. Sharing the negative cable of the speaker or grounding speaker cables to the metal body of the car can cause this unit to fail.
- After installation, check that the brake lamps, wipers, and wipers work properly.

Troubleshooting guide

Often, what appears to be a malfunction is due to user error. Before calling for service, please consult the following table.

Symptom	Cause	Remedy
No sound. (No sound from one side.)	<ul style="list-style-type: none">• Input (or output) cables are disconnected.• The connection of the sigma servo terminals is wrong.• Protection circuit may be activated.• The fuse may be blown because the volume was too high.	<ul style="list-style-type: none">• Connect the input (or output) cables.• Check the connection referring to "Sigma servo feedback".• Check connections by referring to "Power indicator".• Replace the fuse with a new fuse and use a lower volume.
The output level is too small (or too large).	The input sensitivity adjusting control is not set to the correct position.	Adjust the control correctly referring to "Controls".
The sound quality is bad. (The sound is distorted.)	<ul style="list-style-type: none">• The speakers cable are connected with wrong \oplus / \ominus polarity.• A speaker cable is pinched by a screw in the car body.• The switches may be set improperly.	<ul style="list-style-type: none">• Connect them properly checking the \oplus / \ominus of the terminals and cables well.• Connect the speaker cable again so that it is not pinched by anything.• Set switches properly by referring to "Controls".

Specifications

Specifications subject to change without notice.

Audio Section

Max Power Output (2 Ω)	1200 W x 1
Rated Power Output (+B = 12.0 V)	
(4 Ω)	200 W x 1 (20 Hz ~ 20 kHz, 0.05 % THD)
(2 Ω)	400 W x 1 (1 kHz, 0.5 % THD)
Rated Power Output (+B = 14.4 V)	
(4 Ω)	300 W x 1 (20 Hz ~ 20 kHz, 0.05 % THD)
(2 Ω)	600 W x 1 (1 kHz, 0.5 % THD)
Frequency Response (+0, -3 dB)	5 Hz ~ 50 kHz
Total Harmonic Distortion (Rated power)*	0.002 % (1 kHz)
Sensitivity (rated output) (MAX.)	0.2 V
(MIN.)	5.0 V
Signal to Noise Ratio	105 dB
Input Impedance	10 k Ω
Damping Factor	More than 9900 (at Σ connect)
Low Pass Filter Frequency (24 dB/oct.)	50 ~ 200 Hz (variable)
Infrasonic Filter Frequency (24 dB/oct.)	15 / 20 / 25 / 30 Hz
Band Reject Filter Frequency	40 ~ 200 Hz

* Sensitivity = Min. Through LPF (30 kHz)

General

Operating Voltage	12.0 V (11 ~ 16 V allowable)
Current Consumption (4 Ω , +B = 12.0 V, 10 % THD)	36 A
Dimensions (W x H x D)	272 x 58 x 400 mm
	10-11/16 x 2-5/16 x 15-3/4 inch
Weight	6.5 kg
	14.3 lbs

KENWOOD